

COAST[®]



Product Range

Not just brighter...better

2021

 **WHITE[®]**
INTERNATIONAL

COAST[®]

TRUSTED TOUGH.[™]

COAST's build quality has led to some amazing survival stories:

The flashlight that fell 9 stories down an elevator shaft.
And still worked.

The headlamp that spent a night in a cement mixer.
And still worked.

The flashlight that spent a year submerged in a swamp.
And still worked.



COAST®

QUALITY SINCE 1919

COAST Products is a 102-year-old, family-owned company that produces LED lights, knives and multi-tools for work, recreation and everyday use.

COAST produces innovative, technologically advanced products backed by a lifetime warranty that makes the user's life safer, easier, and more enjoyable.



COAST warrants its COAST knives, tools, and COAST LED lights to be free of defects in materials and workmanship for the life of the original purchaser. This warranty does not cover a select range of COAST products, normal wear and tear, nor damage resulting from misuse or neglect. Warranty does not cover batteries and charging accessories (or damage caused by either).

A handwritten signature in white ink that reads "David C. Brands".

David C. Brands — Owner, COAST Products

PRODUCTS & ACCESSORIES

DUAL POWER TECHNOLOGIES	4	XPH PROFESSIONAL HEADLAMPS.....	26
CHARGING TECHNOLOGIES.....	4	RECHARGEABLE & ALKALINE HEADLAMPS	29
HANDHELD LIGHTING TECH	5	PORTABLE WORK LIGHTS	34
ICON KEY.....	8	EMERGENCY AREA LIGHTS (EAL)	37
XP PROFESSIONAL HANDHELDS.....	11	MULTI-TOOLS	41
RECHARGEABLE HANDHELDS	15	BATTERIES & ACCESSORIES.....	44
POLYSTEEL® HANDHELDS.....	17	PRODUCT INDEX.....	45
ALKALINE HANDHELDS.....	22		

COAST DUAL POWER TECHNOLOGIES

COAST is innovative with more than just beams and industrial design. We also put our collective heads together to create power sources and charging technologies that make all our lights even more useful and cost-effective. From price-conscious, yet class-leading alkaline batteries to the most advanced rechargeable systems, COAST leads the way in power.

ALKALINE-DUAL POWER

Comes with COAST'S Extreme Performance Alkaline batteries and is compatible with COAST'S ZITHION-X™ Rechargeable battery.

ZITHION-X™



ZITHION-X™
Rechargeable
Battery



RECHARGEABLE-DUAL POWER

Comes with COAST'S ZITHION-X™ Rechargeable battery and can be used with COAST'S Extreme Performance Alkaline batteries.

ZITHION-X™



ZITHION-X™
Rechargeable
Battery



RECHARGEABLE

Comes with COAST'S embedded ZITHION™ Rechargeable battery and a USB Charging Cord.

ZITHION™



RECHARGEABLE/CONTINUOUS RUN

Comes with COAST'S embedded ZITHION™ Rechargeable battery and a USB charging cord. Can also use plug-in AC power as needed.

ZITHION™



CHARGING TECHNOLOGIES

PRO-TEK CHARGING PORT

Charging made incredibly easy. Just slide open the PRO-TEK port on a PRO-TEK equipped COAST light to access the USB-based charging port. Plug-in to a local AC, DC, or USB power source, and re-charge your light right there. COAST ZITHION-X™ rechargeable batteries also come with a USB charging port and can be charged outside the light for added versatility and time savings.



Slides for charging port access.



AC, DC, USB

PRO-FLEX CHARGING CAP

A clever charging system for certain COAST rechargeable pen lights. When the time comes to recharge, find a convenient AC, DC, or USB power source, slide the PRO-FLEX cap over the end of the light, and it's charging!



To recharge, simply re-cap the torch.

FEATURED ON: COAA9R (805341)



AC, DC, USB

BATTERY LIFE INDICATOR



GREEN
BATTERY IS FULLY CHARGED



RED
BATTERY NEEDS CHARGING



FLASHING RED
BATTERY NEEDS IMMEDIATE CHARGING

HANDHELD TECH – OPTICS

**PURE BEAM FOCUSING OPTIC
ENHANCED FIELD OF VIEW**

Our largest, Ultra View Flood Beam and our Bulls-Eye Spot Beam with transition halo.

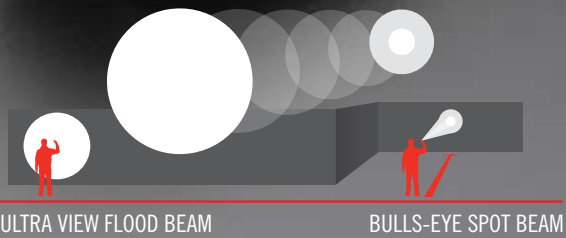

**LONG RANGE FOCUSING OPTIC
ENHANCED DISTANCE**

Our longest, X-Range Spot Beam and our Broad View Flood Beam.

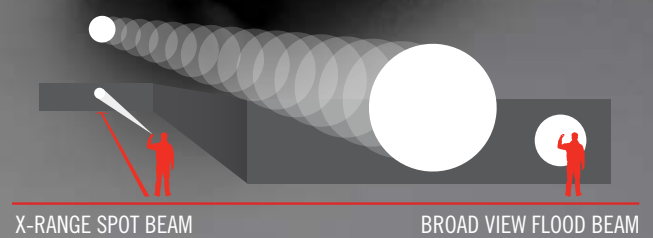

**UNIVERSAL FOCUSING OPTIC
COMPACT SIZE**

A very broad, consistent flood beam and a long distance spot beam.



**INSPECTION BEAM OPTIC
CLEAR, CONSISTENT, DEFINED**

Excellent for illuminating a crisply defined area at closer ranges.



**C.O.B. UTILITY BEAM
EVERYDAY BRIGHT**

A bright, general-use beam created with C.O.B. (Chip On Board) technology.



HANDHELD TECH – CONTROLS

SLIDE FOCUS

Spot to flood light control at your fingertips.
Shape your beam with the simple push or pull of your thumb.

- **PURE BEAM FOCUS**
FLOOD & SPOT
- **LONG RANGE FOCUS**
FLOOD & SPOT



TWIST FOCUS

Twist the head of the light to move between a flood and a spot beam.

- **PURE BEAM FOCUS**
FLOOD & SPOT
- **UNIVERSAL FOCUS**
FLOOD & SPOT



BEAM LOCK

Lock the beam anywhere you want it.
Twist left to lock the beam in place.
Twist back to the right to release.

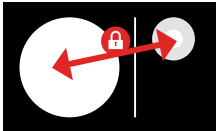

FRONT SWITCH

Easy one-handed on/off activation.



QUICK-CYCLE SWITCH

Control your light power with the push of a button.

Depending on the model, COAST lights may have one of the following illumination sequences:

- High | Low
- High | Medium | Low
- High | Strobe | Low
- High | Strobe



REAR SWITCH/TAIL CAP DESIGN

Many of COAST's lights use a Quick-Cycle tail switch. A tail switch is a well-known feature in the tactical and professional markets. This allows the light to be held up-and-away from one's body while still providing light power control.

COAST's tail cap design also allows many of our lights to stand up straight for vertical lighting applications.



HANDHELD TECH – BUILD & MATERIALS

PURPOSE BUILT

COAST handheld lights are designed to provide both the internal and external functionality required to excel in their intended purposes.

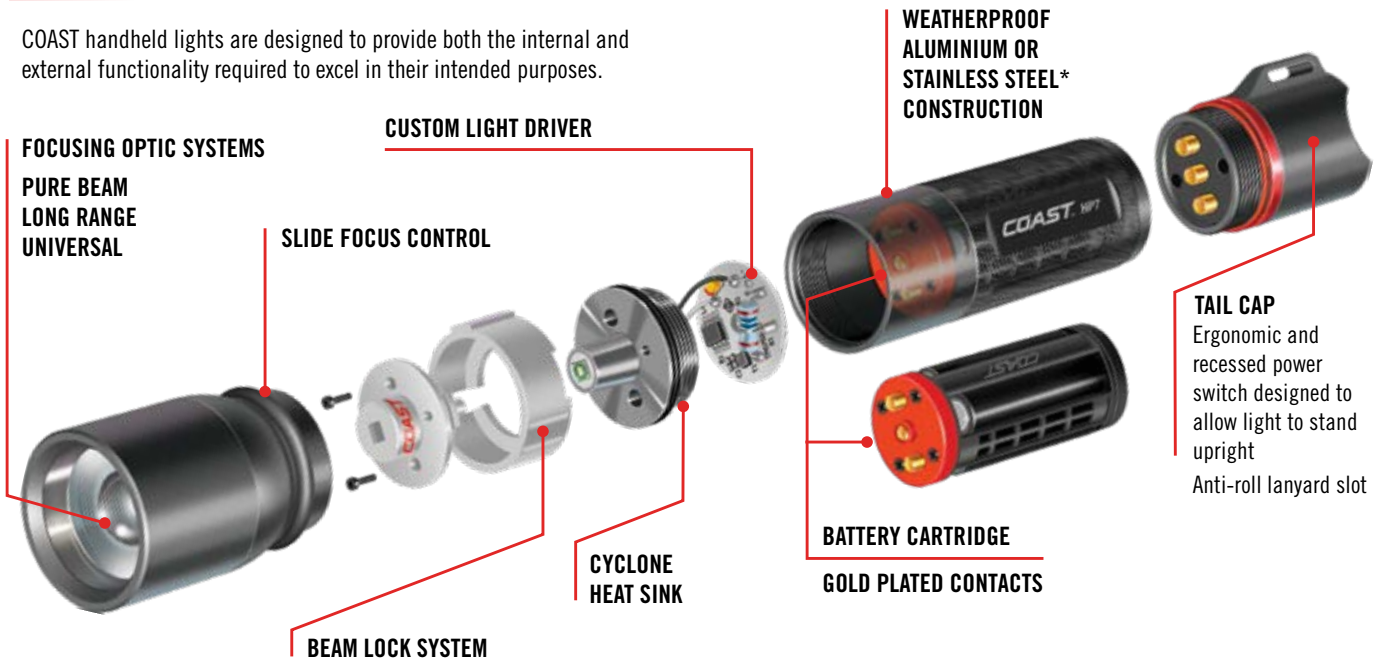

POLYSTEEL®

TOUGH TECH

Take a tough-as-nails stainless steel core, cover it in grip-textured poly-nylon, add a focusing, Pure Beam Optic, and you have POLYSTEEL.



Storm Proof



Dust Resistant



Crush Proof



Drop Proof

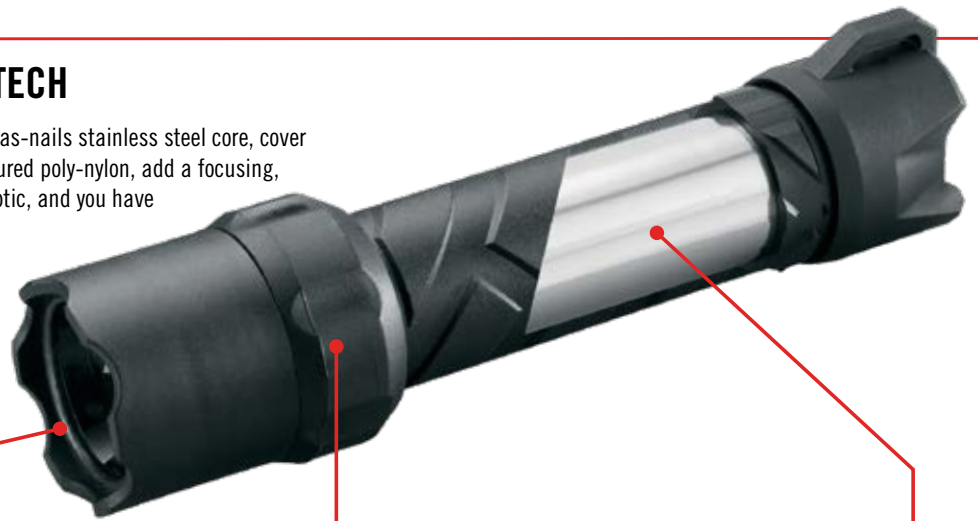

PURE BEAM FOCUSING OPTIC

All POLYSTEEL lights include COAST's patented Pure Beam Focusing Optic systems.



TWIST FOCUS CONTROL

Focus the POLYSTEEL beam by simply twisting the head of the light.



POLY-NYLON OVER STAINLESS STEEL CORE

A fibreglass-reinforced polymer covers a stainless steel core.

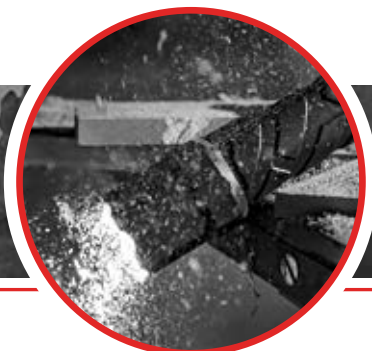

DURABLE

COAST handheld torches are manufactured to withstand constant use. Metal construction*, heavy duty O-rings, and custom battery cartridges are all built to provide longevity and durability.

Not all design features are present on all lights.
*Some COAST lights also use coating materials in their construction.

ICON KEY

OPTICS



BEAM LOCK

Set the beam to stay how you like it. COAST BEAM LOCK® technology makes our SLIDE FOCUS® system even more valuable, with the option to lock the beam in place on spot, flood, or anywhere in between. Twisting the head of the light to the left locks the beam in place, and twisting it back to the right releases the slide mechanism back into motion.



BULLS-EYE SPOT BEAM

Hit your target with power. Always on point, the Bulls-Eye Spot Beam fixes a bright “hot spot” on the object, surrounded by a soft halo of transitional light to increase the total field of view. From spotting animals in the dark to identifying objects, this beam cuts through darkness.



C.O.B. OPTIC

Get brilliant light tailored for specialised formats and use cases. COAST lights featuring Chip on Board (C.O.B.) technology cast a wide beam handy for up-close work—from a strip of LEDs built right onto the chassis, without a standard optic.



DUAL-COLOUR WHITE & RED BEAM

The right light for the moment. The Dual-Colour White & Red Beam combines an all-white Utility Beam for general use with a red, anti-glare beam that prevents “night blinding” while also offering a tool for emergency signalling.



DUAL-COLOUR WHITE & UV BEAM

See beneath the surface. The Dual-Colour White & UV Beam combines an all-white Utility Beam for general use with a UV light for detecting fluid leaks or checking security features on currency and identification cards.



EMERGENCY

Signal duress with flashing, bright-red light. If times get tough, COAST lights outfitted with Emergency mode help attract much-needed attention.



HINGED BEAM

Up, down, or straight ahead. All COAST headlamps feature a hinged, tilting head so that you can adjust the light’s direction and see right where you’re looking.



HIGH MEDIUM LOW

Control your light power with the push of a button. Cycle between full light, medium light and low light options.



HIGH LOW

Control your light power with the push of a button. Cycle between high power and low power options.



INSPECTION BEAM OPTIC

Never miss a detail. The Inspection Beam cuts clean, consistent light from edge to edge to evenly illuminate work spaces. Engineered for pen lights that fit in the pocket, this beam simplifies up-close work and brightens hard-to-reach objects.



LIGHT CONTROL LEVER

Adjust light intensity to meet your need. COAST headlamps featuring a Light Control Lever allow you to fine-tune light output with one hand by simply moving the lever positioned on the back of the headlamp.



PURE-BEAM FOCUSING OPTIC

Pack two powerful beams into one and seamlessly transition—with no halos or hot spots—between short and long-range viewing. COAST’s patented focusing technology adapts to your need. The Ultra View Flood beam delivers edge-to-edge clarity in a broad circle, and the BULLS-EYE™ Spot Beam sends a sharp ray of light at a distance with a transitional halo around the spot to increase the effective viewing area.



REAR SWITCH TAIL CAP

Design enables hands free vertical lighting.



SINGLE MODE

The same light every time. Keeping it simple with COAST single-mode lighting means you can rely on an even, bright white beam every time.



SLIDE FOCUS

One-handed beam control. COAST’s SLIDE FOCUS® system enables you to seamlessly transition between spot and flood beam with the push or pull of your finger. Responsive beam-shape control allows you to operate your light with a single hand and keep the other hand free.



TURBO MODE

The XP lights not only feature standard light modes but also COAST’s signature Turbo Mode for overpowered light in critical situations.



TWIST FOCUS

Dial in the shape of light you need for the situation. COAST’s TWIST FOCUS™ system makes it easy to move between spot and flood beams by simply rotating the head of the flashlight.



UTILITY BEAM OPTIC

Take it everywhere—the ultimate, all-around light for general use. COAST’s Utility Beam shines three individual, overlapping beams to create a broad, multi-bright field of light—with a concentrated, vivid center and diffuse, radiant edges.



VARIABLE LIGHT CONTROL TECHNOLOGY

Easily adjust headlamp light output. COAST Variable Light Control Technology provides three ways to precisely regulate beam intensity.



WIDE ANGLE FLOOD BEAM OPTIC

See the whole scene at once. The Wide Angle Flood Beam illuminates the broadest possible area with vivid, consistent light from edge to edge.

CHARGING



BATTERY CHARGES INSIDE LIGHT

COAST ZITHION™ non-ported rechargeable batteries are built to charge from within your COAST light using a COAST charging system.



BUILT-IN USB-C PORT

Charge directly from AC, DC, and USB. Flashlights and headlamps with COAST PRO-TEK Charging include a direct-connect port for powering back up.



BATTERY LIFE INDICATOR

With a battery-life indicator, you can always know when your battery needs to be recharged.



CHARGING CAP

Power up your penlight by putting on its cap. The COAST Pro-Flex Charging Cap makes recharging as easy and intuitive as replacing the cap on a pen.



CONTINUOUS AC/DC POWER

You can continuously run this work light using an AC/DC power cord.



DUAL POWER

Options to stay ready. With COAST Dual Power technology, you have the choice to power your light with USB-rechargeable batteries or with standard alkaline batteries.



DUAL POWER (LI-ION/CONTINUOUS)

You can power the work light by using the rechargeable battery or continuously run the light on an AC/DC power cord.



ENERGY SAVING

Conserve battery life with precise light control. Make easy adjustments to match your light's intensity to the circumstance. COAST EAL multi-mode technology enables seamless transition from energy-saving low-light output to area-illuminating high output and anywhere in between.



EXTERNAL DEVICE CHARGING

Power any USB-enabled device. Select COAST work lights feature a special external charging system that allows other devices to recharge directly from the work light's battery.



OVERCHARGE/DISCHARGE PROTECTION CIRCUITS

Over charging and improperly discharging lithium batteries can cause a safety concern and hazardous risk to the user and it's surroundings. COAST batteries are built with overcharge/discharge protection, ensuring you and your battery are protected.



PRO-TEK CHARGING

Charge directly from AC, DC, and USB. Flashlights and headlamps with COAST PRO-TEK Charging include a direct-connect port for powering back up.



RECHARGEABLE DUAL POWER

Each COAST Rechargeable-Dual Power product comes with a ported ZITHION-X™ rechargeable battery or a non-ported ZITHION™ rechargeable battery and is compatible with either COAST Extreme Performance alkaline batteries or other brand-name battery types, depending on the product. This provides you the cost savings of using rechargeable and the flexibility of reverting to alkaline.

DURABILITY



CRUSH PROOF

The Crush Proof feature combines a super-tough stainless steel core with a grip-textured poly-nylon exterior to build unimaginable strength into highly functional lights.



DROP PROOF

Drop Proof for use in rugged, high-impact environments.



DUST RESISTANT

Take on any dirty work environment with this dust resistant light.



STORM PROOF

Ride out storms with light. The crushproof, weatherproof area light shines bright or sends a signal when the wind and rain cause outages.



Weatherproof

Keep the light on no matter the weather. With IP54 resistance to splashes, sprays, and downpours.



WATER RESISTANCE

Don't worry about the weather. COAST lights that have passed the IP54-level resistance tests are splash-resistant and built with durable materials that stand up to nature.

WHAT IS IP54 Weatherproof?

A product with an IP54 rating is protected against dust ingress sufficient to prevent the product from operating normally but it's not dust tight. The product is fully protected against solid objects and splashing of water from any angle.

ICON KEY

FEATURES



180-DEGREE HANDLE ROTATION

Put the handle right where you need it. An adaptive handle on the work light enables you to rotate the handle up to 180 degrees for optimal placement.



180-DEGREE ROTATION (AREA LIGHT)

Put the beam right where you need it. An adaptive head on the work light enables you to rotate the beam up to 180 degrees for optimal placement.



360-DEGREE HANDLE ROTATION

Put the handle right where you need it. An adaptive handle on the work light enables you to rotate the handle up to 360 degrees for optimal placement.



BASE HANGING LOOP

Hang the light for perfect illumination—with a base hanging loop that can be attached for perfect positioning.



HAT CLIP

Store it away or shine it forward. The Two-Way Clip enables flexibility to stash the light in your pocket or clip it to the brim of your hat.



HARDHAT COMPATIBLE

Rugged enough for the outside of the hardhat. COAST headlamps with Hardhat Compatible design include clips for attaching the light to the hat.



MAGNETIC BASE

Attach the light to magnetic surfaces. Lights with a Magnetic Base have magnets located on their base that allow the light to be attached to magnetic surfaces for easy storage or hands-free use.



MAGNETIC TAIL CAP

Attach the light to magnetic surfaces. COAST lights with a Magnetised Tail Cap have an integrated magnet that enable you to affix the light to magnetic surfaces for easy storage or hands-free use.



REFLECTIVE STRAP

Stay visible in the dark. Some COAST headlamps feature a Reflective Strap to increase safety and ensure user visibility in low light.

XP PROFESSIONAL RECHARGEABLE HANDHELDS

IP54



Weatherproof



Dust Resistant



ZITHION-X™
Rechargeable
Battery



NEW!  **COAXP18R (809489)**

3650 Lumens | 330m Beam | IP54



Lanyard ring

PURE BEAM® FOCUS
FLOOD & SPOT

Medium | High | Low | Turbo
1-Handed Slide Focus

Length: 26.3cm | 10.3"
Weight: 550g | 19.4oz















Battery Life Indicator

Defeat the dark with pure force. As the most powerful flashlight in our XP professional series, the XP18R overwhelms any lighting challenge with dynamic, brightest-in-class light and four-mode, multi-beam capability. Featuring COAST Rechargeable Dual Power technology, this IP54 dust-resistant and storm proof powerhouse runs on a COAST ZITHION-X™ rechargeable battery or standard alkaline AA's with power monitored by a real-time battery life indicator so that you're always ready. COAST-patented SLIDE FOCUS® optical technology shines the Ultra View Flood Beam and BULLS-EYE™ Spot Beam with seamless transitions between.

ANSI FL1 (Rec)	Medium	High	Low	Turbo
Lumens	420	1460	65	3650
Beam Distance	110m	206m	44m	330m
Runtime	9h 30min	6h 30min	58h 30min	

FEATURES:

-  **BEAM LOCK**
-  **BULLS-EYE SPOT BEAM**
-  **REAR SWITCH TAIL CAP**
-  **SLIDE FOCUS**
-  **TURBO MODE**
-  **BATTERY CHARGES INSIDE LIGHT**
-  **BUILT-IN USB-C PORT**
-  **BATTERY LIFE INDICATOR**
-  **PRO-TEK CHARGING**
-  **RECHARGEABLE DUAL POWER**
-  **DUST RESISTANT**
-  **WEATHER PROOF**

RECHARGEABLE-DUAL POWER

- 1 × COAST ZX960 ZITHION-X™ Rechargeable battery
- USB-C Y split charging cable
- Alkaline battery cartridge

ALSO COMPATIBLE WITH:

- 6 × AA Alkaline batteries (not included)

Patented Optics System
PURE BEAM® FOCUS

ULTRA VIEW FLOOD
for up close

BULLS-EYE SPOT
for distance

1-Handed SLIDE FOCUS

Flood

Spot

MEDIUM

HIGH

LOW

TURBO

QUICK-CYCLE SWITCH SYSTEM
TO ACTIVATE TURBO MODE,
PRESS AND HOLD POWER
BUTTON FOR TWO SECONDS

NEW!



COAXP11R (809490)

2100 Lumens | 220m Beam | IP54

**PURE BEAM®
FOCUS**
FLOOD & SPOT

Medium | High | Low | Turbo
1-Handed Slide Focus



Length: 15cm | 5.9"
Weight: 237g | 8.35oz

Cut through deep darkness. The XP11R showcases how power meets performance in our XP professional series, delivering ultra-bright light and four-mode, multi-beam capability — bold enough for midnight searches whilst being light weight. Featuring COAST Rechargeable Dual Power technology, this IP54 dust-resistant and storm proof flashlight includes a real-time power indicator so that you always know when to power up. COAST-patented SLIDE FOCUS® optical technology shines the Ultra View Flood Beam and BULLS-EYE™ Spot Beam with seamless transitions.

ANSI FL1 (Rec)	Medium	High	Low	Turbo
Lumens	330	1000	75	2100
Beam Distance	88m	155m	42m	220m
Runtime	7h 15min	5h	37h	

FEATURES:



BEAM LOCK



BULLS-EYE SPOT BEAM



REAR SWITCH TAIL CAP



SLIDE FOCUS



TURBO MODE



BATTERY CHARGES INSIDE LIGHT



BUILT-IN USB-C PORT



BATTERY LIFE INDICATOR



PRO-TEK CHARGING



RECHARGEABLE DUAL POWER



DUST RESISTANT



WEATHER PROOF

RECHARGEABLE-DUAL POWER

1 × COAST ZX1000 ZITHION-X™ Rechargeable battery
USB-C Y split charging cable
Alkaline battery cartridge

ALSO COMPATIBLE WITH:

3 × AAA Alkaline batteries (not included)



NEW!  **COAXP9R (809491)**

1000 Lumens | 225m Beam | IP54



Medium | High | Low
1-Handed Slide Focus

Length: 12.95cm | 5.1"
Weight: 160g | 5.6oz



Lanyard ring

Pack bold lighting power wherever work takes you. A small but mighty workhorse in our XP series of professional flashlights, the XP9R delivers brightest-in-class light. Featuring Rechargeable Dual Power technology and the patented SLIDE FOCUS® optical technology ensures you can meet the moment with flawless transitions between Ultra View Flood Beam and BULLS-EYE™ Spot Beam.

ANSI FL1 (Rec)	Medium	High	Low
Lumens	350	1000	67
Beam Distance	125m	225m	55m
Runtime	8h	3h 10min	25h

FEATURES:



BEAM LOCK



BULLS-EYE SPOT BEAM



REAR SWITCH TAIL CAP



SLIDE FOCUS



BUILT-IN USB-C PORT



RECHARGEABLE DUAL POWER



DUST RESISTANT



WEATHER PROOF

RECHARGEABLE-DUAL POWER

1 × COAST ZX850 ZITHION-X™ Rechargeable battery
USB-C Y split charging cable

ALSO COMPATIBLE WITH:

2 × CR123 Lithium batteries (not included)

NEW!  **COAXP6R (809492)**

400 Lumens | 180m Beam | IP54



Medium | High | Low
1-Handed Slide Focus

Length: 9.0cm | 3.5"
Weight: 75g | 2.6oz



Lanyard ring

Ultra-light and ultra-bright. The XP6R flashlight delivers brightest-in-class light. It travels anywhere in a pocket, in a cup holder, or strung from a lanyard and features patented SLIDE FOCUS® optical technology that transitions seamlessly between Ultra View Flood Beam and BULLS-EYE™ Spot Beam.

ANSI FL1 (Rec)	Medium	High	Low
Lumens	150	400	35
Beam Distance	110m	180m	53m
Runtime	5h	1h 55min	10h

FEATURES:



BEAM LOCK



BULLS-EYE SPOT BEAM



REAR SWITCH TAIL CAP



SLIDE FOCUS



BUILT-IN USB-C PORT



RECHARGEABLE DUAL POWER



DUST RESISTANT



WEATHER PROOF

RECHARGEABLE-DUAL POWER

1 × COAST ZX310 ZITHION-X™ Rechargeable battery
USB charging cable

ALSO COMPATIBLE WITH:

1 × CR123 Lithium batteries (not included)

RECHARGEABLE HANDHELDS



COAHP3R (805054) 245 Lumens | 93m Beam | IP54

UNIVERSAL FOCUS
FLOOD & SPOT

High | Low
Twist Focus

Length: 14.8cm | 5.8"
Weight: 51g | 1.8oz

Penlights with the Flex Power system, harnesses either lithium or alkaline power. With high and low modes and the twist focus, this light is a supercharged penlight capable of anything.

ANSI FL1 (Rec)	High	Low
Lumens	245	26
Beam Distance	93m	31m
Runtime	1h 30min	6h

ANSI FL1 (Alk)	High	Low
Lumens	86	10
Beam Distance	55m	19m
Runtime	2h	26h



FEATURES:



TWIST FOCUS



HIGH LOW



BATTERY CHARGES INSIDE LIGHT



RECHARGEABLE DUAL POWER



PRO-TEK CHARGING



DUST RESISTANT



WATER RESISTANCE

RECHARGEABLE-DUAL POWER

1 × COAST Z500 ZITHION-X™ Rechargeable battery
AC with USB adapters

ALSO COMPATIBLE WITH:

2 × AAA batteries

COAA9R (805341) 26 Lumens | 20m Beam | IP54

INSPECTION BEAM
LOW GLARE

Single Mode

Length: 15.7cm | 6.2"
Weight: 60g | 2.1oz

With a sleek design and recharging capability, the A9R Flashlight is the go-to penlight for serious technicians. It has our Inspection Beam that throws out a perfectly circular beam without any dark spots that make up close inspections immediately easier. It recharges by placing a charging cap over the head of the light and works with any USB port.

ANSI FL1 (Rec)	Low
Lumens	20
Beam Distance	20m
Runtime	3h



PRO-FLEX CHARGING CAP



Green light indicates when charged

FEATURES:



INSPECTION BEAM OPTIC



SINGLE MODE



CHARGING CAP

RECHARGEABLE POWER

1 × COAST Z250 ZITHION-X™ Rechargeable battery
AC+DC with USB adapters

POLYSTEEL[®] HANDHELDS



Storm Proof



Dust Resistant



Crush Proof



Drop Proof



POLYSTEEL

TOUGH TECH

Take a tough-as-nails stainless steel core, cover it in grip-textured Poly-Nylon, add a focusing Pure Beam Optic, and then top it off with COAST's exceptional warranty and you have POLYSTEEL.

Most POLYSTEEL torches have passed the IPX8-level waterproof test while under 3 meters of water for 6 hours. POLYSTEEL torches have also passed the ANSI FL1 drop test from up to 3 meters in height (depending on model). COAST has also done some real-world "tough testing", ultimately crushing a POLYSTEEL torch under the track of a massive logging loader. The result? The torch was still on, doing its job.

REAL-WORLD TOUGH TESTS



*only on selected Polysteel lines

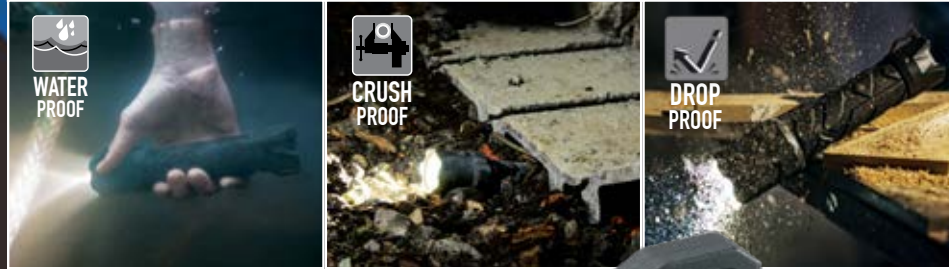

POLY-NYLON OVER STAINLESS STEEL CORE

POLYSTEEL perfectly describes how these torches are constructed. A fiberglass-reinforced polymer covers a stainless steel core to create a torch capable of withstanding serious, professional level use. (NOTE: cutaway shown; poly covers entire handle area).



PURE BEAM FOCUSING OPTIC

Tough doesn't mean you have to skimp on features. All POLYSTEEL torches include COAST's patented Pure Beam Focusing Optic system for outstanding beam shape at all ranges.



3-LEVEL REAR SWITCH

The rear power switch controls high / medium / low light settings to provide just the right beam intensity for the application.



TWIST FOCUS CONTROL

The same focusing system found on other high-end COAST torches allow the user to focus the POLYSTEEL beam by simply twisting the head of the torch.

NEW! **COAPS700R (809480)**

800 Lumens | 260m Beam | DUAL C.O.B. Area Lights

Coming soon 2021. Check with your stockist



Medium | High | Low
Twist Focus

Length: 21.4cm | 8.4"
Weight: 356g | 12.5oz



Lanyard ring

The storm proof, drop-proof, and dust proof PS700R C.O.B. features a magnetic tail cap for easy positioning and a twist-focusing main optic supported by two ultra-bright, handle-mounted C.O.B.s with solid flashing modes in both white and red. It also makes it easy to affix the light to metal surfaces for hands-free, directional lighting from the twist-focusing flood-to-spot main beam. With seven unique light modes - including red and red flashing from C.O.B.s on the handle - the light can become an emergency signal attached to a car or other metallic surfaces. Whether on the job, around the home, or out on the road, this flashlight is the always-ready solution.



DUAL C.O.B. Area Lights

ANSI FL1 (Rec)	Medium	High	Low
Lumens	200	510	50
Beam Distance	130m	200m	70m
Runtime	18h	7h	80h

ANSI FL1 (Aik)	Medium	High	Low
Lumens	380	800	105
Beam Distance	175m	260m	90m
Runtime	11h	3h 30min	40h

FEATURES:



ALKALINE-DUAL POWER

1 x COAST ZX650 ZITHION-X™ Rechargeable battery
1 x Alkaline battery cartridge

ALSO COMPATIBLE WITH:

4 x AA Alkaline batteries (not included)

COAPS600 (805062)

710 Lumens | 240m Beam | IPX8



High | Medium | Low
Twist Focus

Length: 20cm | 7.9"
Weight: 330g | 11.6oz



Lanyard ring

The PS600 flashlight is storm proof, drop proof, and crush proof while possessing our Pure Beam Optics System with twist focus, to make the light ultra durable and ready to weather any storm.

ANSI FL1 (Aik)	High	Medium	Low
Lumens	710	245	73
Beam Distance	240m	142m	78m
Runtime	2h 14min	5h 15min	30h

FEATURES:



ALKALINE-POWER

4 x AA Alkaline batteries

NEW! **COAPS400S (809481)** 440 Lumens | 210m Beam | IPX8

PURE BEAM® FOCUS
FLOOD & SPOT

High | Medium | Low
Twist Focus

Length: 19.5cm | 7.6"
Weight: 244g | 8.6oz



SWIVEL HEAD

Lanyard ring

Work hands-free in full light with a virtually indestructible flashlight whose magnetic base connects to metal surfaces. A 180-degree rotating head delivers either a spot or flood beam where it's needed using COAST's patented beam-shaping optical technology. Freedom to use both hands can be critical to doing the job well. The PS400S, is not only drop-proof, crushproof, and storm proof. It's also pocket-sized, with a magnetic tail cap for easy connection to surfaces, allowing you to position and shine the light right where you need it.

ANSI FL1 (Alk)	High	Medium	Low
Lumens	440	200	60
Beam Distance	210m	142m	75m
Runtime	4h	10h	27h

FEATURES:



HIGH MEDIUM LOW



REAR SWITCH TAIL CAP



TWIST FOCUS



CRUSH PROOF



DROP PROOF



DUST RESISTANT



STORM PROOF



MAGNETIC TAIL CAP

ALKALINE-POWER

4 × AAA Alkaline batteries



COAPS200 (805082)

320 Lumens | 120m Beam | IPX8



High | Medium | Low
Twist Focus

Length: 12.7cm | 5.0"
Weight: 120g | 4.2oz





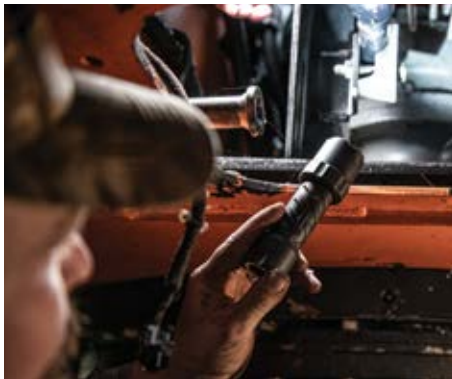

The smallest size of the collection, the PS200 Flashlight is storm proof, drop proof, and crush proof while possessing our Pure Beam Optics System with twist focus to make the light ultra durable and ready to weather any storm.

ANSI FL1 (Aik)	High	Medium	Low
Lumens	320	125	40
Beam Distance	120m	80m	43m
Runtime	4h 30min	12h	38h



Lanyard ring

FEATURES:

- 
**HIGH
MEDIUM
LOW**
- 
**REAR SWITCH
TAIL CAP**
- 
**TWIST
FOCUS**
- 
**CRUSH
PROOF**
- 
**DROP
PROOF**
- 
**DUST
RESISTANT**
- 
**STORM
PROOF**

ALKALINE-POWER
3 × AAA Alkaline batteries

NEW!

COAPS100 (809482)

110 Lumens | 42m Beam

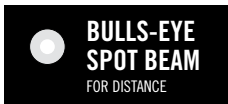

High | Low







Length: 15cm | 5.9"
Weight: 53g | 1.8oz

The PS100 is designed for anyone who needs a small, very powerful, pocket-sized light that can withstand any condition and do any lighting job you need to be done. It is fully tested to be dust proof, crushproof, drop-proof, and storm proof. The very slim PS100 fits nicely in a shirt pocket, safety vest, or pants pocket.

ANSI FL1 (Aik)	High	Low
Lumens	110	48
Beam Distance	42m	28m
Runtime	4h 15min	14h 30min



FEATURES:

- 
**HIGH
LOW**
- 
**REAR SWITCH
TAIL CAP**
- 
**CRUSH
PROOF**
- 
**DROP
PROOF**
- 
**DUST
RESISTANT**
- 
**STORM
PROOF**

ALKALINE-POWER
2 × AAA Alkaline batteries

ALKALINE HANDHELDS



COAHP7 (805057)

650 Lumens | 200m Beam | IPX4



High | Medium | Low
Slide Focus + Beam Lock

Length: 14.2cm | 5.6"
Weight: 198g | 7.0oz



A perfect mix of size, form, and performance, the HP7 Flashlight is rightfully one of our most popular handheld lights. It combines our Pure Beam Focusing System with Slide Focus with a high, medium, and low output modes to illuminate with either a super wide flood beam or spot beam with transition halo at varying distances and brightness all controllable with one hand. Its anti-roll tail cap allows you to set it on uneven surfaces without rolling off and it even allows you to stand the light upon its cap for vertical lighting situations. The HP7 Flashlight is impact resistant, weather resistant and its LED is virtually unbreakable.

ANSI FL1 (Aik)	High	Medium	Low
Lumens	650	330	90
Beam Distance	200m	135m	75m
Runtime	3h	3h 15min	6h 30min

FEATURES:



ALKALINE-POWER
4 x AAA Alkaline batteries

COAHX5 (805094)

360 Lumens | 130m Beam | IP54



Slide Focus

Length: 10.2cm | 4.0"
Weight: 80g | 2.8oz



The HX5 Flashlight is a two-way clip that makes it easy to clip in either direction on your pockets or even the bill of your hat. Using our Pure Beam Focusing System with Slide Focus, this light can easily transition from flood to spot modes with one hand.

ANSI FL1 (Aik)	Alkaline	NiMH	Li Ion
Lumens	168	125	360
Beam Distance	88m	77m	130m
Runtime	3h 15min	1h 15min	1h 10min

FEATURES:



ALKALINE-DUAL POWER
1 x AA battery

ALSO COMPATIBLE WITH:
1 x COAST ZX210 ZITHION-X™ Rechargeable battery upgrade available or 1 x NiMH (not included)

COAHP3 (805052)

105 Lumens | 62m Beam | IPX4



High | Low
Twist Focus

Length: 14.6cm | 5.75"
Weight: 57g | 2.0oz

With a compact body and pocket clip added to our Universal Focusing System, this gives you the ability to have the wide flood for up-close work or focus to a spot beam for longer distances.

ANSI FL1 (Aik)	High	Low
Lumens	105	5
Beam Distance	62m	13m
Runtime	2h 15min	3h 30min



FEATURES:



HIGH
LOW



TWIST
FOCUS



DUST
RESISTANT



WATER
RESISTANCE

ALKALINE-POWER
2 × AAA Alkaline batteries

COAG20 (805076)

21m Beam | IP54

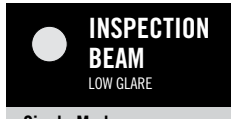

Single Mode

Length: 14.4cm | 5.7"
Weight: 70g | 2.5oz

Whether you store it in your shirt pocket, pants pockets, or a tool bag, the G20 Flashlight with its Inspection Beam Optic is a light that you should keep close. Optimised for up close use with its crisp edges and little glare, the perfectly circular beam illuminates where and when you need it.

ANSI FL1 (Aik)	
Beam Distance	21m
Runtime	11h



FEATURES:



SINGLE
MODE



IP54 WATER
RESISTANCE

ALKALINE-DUAL POWER
2 × AAA battery

ALSO COMPATIBLE WITH:
1 × COAST ZX110 ZITHION-X™ Rechargeable battery (not included)

COAG15 (805075)

20m Beam | IPX4

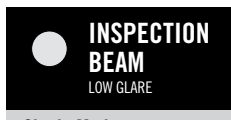

Single Mode

Length: 10.2cm | 4.0"
Weight: 54g | 1.9oz

Attached to a spring loaded mounting clip, the G15 Flashlight with the Inspection Beam Optic is the perfect option when you are working with your hands in tight places. With an incredibly clear and consistent beam from edge to edge, the light is perfect for all sorts of up close uses, and when removed from the clip, it has a key ring hole on the back for extra versatility.

ANSI FL1 (Aik)	
Beam Distance	20m
Runtime	2h 30min



FEATURES:



SINGLE
MODE



IPX4 WATER
RESISTANCE

ALKALINE POWER
1 × AAA Alkaline batteries

COAHX4 (805673) 80 Lumens | 13m Beam | IPX4

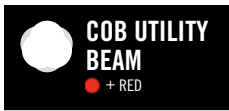

Single Mode

Length: 7.9cm | 3.1"
Weight: 50g | 1.7oz



Magnetised clip for versatile mounting



The HX4 LED C.O.B. Clip light is the ideal dual color everyday carry light. By combining red and white LEDs, the HX4 LED Clip light is excellent when you need bright illumination or need to use it in situations where you need to preserve your night vision. The universal clip on the light makes it easy to clip on pockets or even the bill of your hat, while the integrated magnets allow the HX4 to be placed on magnetic surfaces. Once placed or clipped to a surface, the light features a 180-degree beam adjustment.

ANSI FL1 (Aik)

Lumens 80
Beam Distance 13m
Runtime 3h 45min

FEATURES:

- DUAL-COLOR
WHITE & RED
BEAM**
- SINGLE
MODE**
- IPX4 WATER
RESISTANCE**
- HAT
CLIP**
- MAGNETIC
TAIL CAP**

ALKALINE-POWER
2 × AAA Alkaline batteries

COAHX3 (805674) 80 Lumens | 13m Beam | IPX4

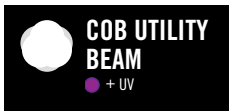

Single Mode

Length: 7.9cm | 3.1"
Weight: 50g | 1.7oz



Magnetised clip for versatile mounting



The HX3 LED C.O.B. Clip light is the ideal UV light for everyday carry. The HX3 Clip light can be used for either general uses in White mode or to identify leaks or to identify security features in either currency or identification cards while in UV mode. The universal clip on the light makes it easy to clip on pockets or even the bill of your hat, while the integrated magnets allow the HX3 to be placed on magnetic surfaces. Once placed or clipped to a surface, the light features a 180-degree beam adjustment.

ANSI FL1 (Aik)

Lumens 80
Beam Distance 13m
Runtime 3h 45min

FEATURES:

- DUAL-COLOR
WHITE & UV
BEAM**
- SINGLE
MODE**
- IP54 WATER
RESISTANCE**
- HAT
CLIP**
- MAGNETIC
TAIL CAP**

ALKALINE-POWER
2 × AAA Alkaline batteries

XPH PROFESSIONAL RECHARGEABLE HEADLAMPS

IP54



Weatherproof



Dust Resistant



ZITHION-X™
Rechargeable
Battery



NEW!  **COAXPH34R (809493)** 2075 Lumens | 195m Beam | IP54

Coming soon 2021. Check with your stockist

PURE BEAM®
FOCUS
 FLOOD & SPOT

Medium | High | Low | Turbo
 Twist Focus

Weight: 227g | 8.0oz















Go hands-free or hands-on with the brightest headlamp in the XPH line. Built to be worn or held in your hand, the XPH34R features a dust-resistant and storm proof aluminium body that rolls in its bracket for directional lighting and also detaches to become a full-featured flashlight with a magnetic tail cap and built-in power indicator. The COAST-patented PURE BEAM® optical system with TWIST FOCUS™ enables seamless transitions between ULTRA VIEW FLOOD BEAM and BULLS-EYE™ Spot Beam.

ANSI FL1 (Rec)	Medium	High	Low	Turbo
Lumens	330	1025	73	2075
Beam Distance	78m	136m	36m	195m
Runtime	11h 15min	6h 15min	36h	



FEATURES:

- 
BULLS-EYE SPOT BEAM
- 
HINGED BEAM
- 
TURBO MODE
- 
TWIST FOCUS
- 
BATTERY LIFE INDICATOR
- 
PRO-TEK CHARGING
- 
RECHARGEABLE DUAL POWER
- 
DUST RESISTANT
- 
WEATHER PROOF
- 
HARDHAT COMPATIBLE
- 
REFLECTIVE STRAP
- 
MAGNETIC TAIL CAP

RECHARGEABLE-DUAL POWER

- 1 × COAST ZX955 ZITHION-X™ Rechargeable battery
- USB-C Y split charging cable
- Alkaline battery cartridge

ALSO COMPATIBLE WITH:

- 3 × AAA Alkaline batteries (not included)

NEW!  **COAXPH30R (809494)** 1000 Lumens | 165m Beam | IP54

PURE BEAM® FOCUS
FLOOD & SPOT

Medium | High | Low | Turbo
Twist Focus

Weight: 77g | 2.7oz















Shine bright and stay hands-free with the mid-size workhorse in the XPH professional headlamp series. Patented PURE BEAM® technology with a TWIST FOCUS™ optic enables seamless transitions between Ultra View Flood Beam and BULLS-EYE™ Spot Beam. This headlamp's dust-resistant and storm proof aluminium body rolls in its bracket for dynamic directional lighting — and can also detach to become a handheld flashlight with a built-in magnetic tail cap and real-time power indicator.

ANSI FL1 (Rec)	Medium	High	Low	Turbo
Lumens	150	490	40	1000
Beam Distance	63m	112m	31m	165m
Runtime	10h	7h 45min	41h	

RECHARGEABLE-DUAL POWER
1 × COAST ZX850 ZITHION-X™ Rechargeable battery
USB-C Y split charging cable

ALSO COMPATIBLE WITH:
2 × CR123 Lithium batteries (not included)

FEATURES:

 BULLS-EYE SPOT BEAM	 HINGED BEAM	 TURBO MODE	 TWIST FOCUS
 BATTERY LIFE INDICATOR	 PRO-TEK CHARGING	 RECHARGEABLE DUAL POWER	 DUST RESISTANT
 WEATHER PROOF	 HARDHAT COMPATIBLE	 REFLECTIVE STRAP	 MAGNETIC TAIL CAP

NEW!  **COAXPH25R (809495)** 410 Lumens | 120m Beam | IP54

PURE BEAM® FOCUS
FLOOD & SPOT

Medium | High | Low
Twist Focus

Weight: 76g | 2.7oz















Work hands-free with the lightest-weight model in the XPH line of professional headlamps. Designed to deliver heavyweight performance from a compact frame, this headlamp is built from top-grade aluminium and features a dust-resistant and storm proof body that rolls in its bracket for dynamic directional lighting — which can also detach to become a handheld flashlight with a built-in magnetic tail cap and real-time power indicator. The COAST-patented PURE BEAM® optical system with TWIST FOCUS™ enables seamless transitions between Ultra View Flood Beam and BULLS-EYE™ Spot Beam.

ANSI FL1 (Rec)	Medium	High	Low
Lumens	155	410	42
Beam Distance	75m	120m	38m
Runtime	4h 15min	1h 45min	9h 15min

RECHARGEABLE-DUAL POWER
1 × COAST ZX310 ZITHION-X™ Rechargeable battery
USB charging cable

ALSO COMPATIBLE WITH:
1 × CR123 Lithium batteries (not included)

FEATURES:

 BULLS-EYE SPOT BEAM	 HINGED BEAM	 TWIST FOCUS	 BATTERY LIFE INDICATOR
 BUILT-IN USB PORT	 PRO-TEK CHARGING	 RECHARGEABLE DUAL POWER	 DUST RESISTANT
 WEATHER PROOF	 HARDHAT COMPATIBLE	 REFLECTIVE STRAP	 MAGNETIC TAIL CAP

RECHARGEABLE & ALKALINE HEADLAMPS



HEADLAMP TECH – OPTICS, CONTROLS & FUNCTIONALITY



PURE BEAM FOCUSING OPTIC

ENHANCED FIELD OF VIEW

Our largest, Ultra View Flood Beam and our Bulls-Eye Spot Beam with transition halo. The Bulls-Eye Spot provides good viewing up to 214 metres and the Ultra View Flood Beam provides a consistent circle of light up to 3.5 metres in diameter at a distance of 1.8 metres.

Available with secondary red utility beam ● + RED

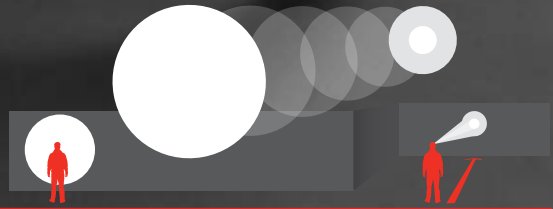

ULTRA VIEW FLOOD BEAM

3.5m across at 1.8m
Ultra View Flood also available as stand-alone optic.

BULLS-EYE SPOT BEAM

Up to 214m
Bulls-Eye Spot also available as stand-alone optic.

BEAM SHAPING

The Twist Focus Ring makes it easy to go from Ultra View Flood Beam to Bulls-Eye Spot.



EASY ON/OFF

COAST headlamps have several different power switch designs, but all are easy to use.



REFLECTIVE SAFETY STRAP

Certain COAST head torches include a reflective safety strap for additional user visibility in low light.



HINGED BEAM ADJUSTMENT

ALL COAST head torches include a hinged, tilting head to let you adjust direction of the light beam.



HARDHAT COMPATIBILITY

Certain COAST head torches include clips for hardhat compatibility.

COAHL7R (805081) 240 Lumens | 104m Beam | IPX4



Variable Light Tech (VLT)
Twist Focus

Weight: 125g | 4.4oz

EXTERNAL CHARGING PORT



LIGHT CONTROL
Control Lever



Both focusing and rechargeable, the HL7R Headlamp is ready to be a workhorse day in and day out. It gives you the ability to shine an ultra-wide flood beam and then quickly twist the bezel to a long reaching spot beam with transition halo so that you can be ready for anything. With our Variable Light Control Technology on board you can adjust the light output with the control lever to any point between low and high so you can have highly personalized output and run times. Using a mini USB directly into the back of the headlamp, you can quickly and easily charge the NiMH batteries and get back to work.

ANSI FL1 (Rec)	High	Low
Lumens	240	4
Beam Distance	104m	13m
Runtime	1h 30min	40h

FEATURES:



HINGED BEAM



LIGHT CONTROL LEVER



TWIST FOCUS



VARIABLE LIGHT CONTROL TECHNOLOGY



EXTERNAL DEVICE CHARGING



HARDHAT COMPATIBLE



WATER RESISTANCE

RECHARGEABLE POWER

3 × COAST Z100 ZITHION™

ALSO COMPATIBLE WITH:

3 × AAA battery (not included)



COAFL85 (805100) 650 Lumens | 192m Beam | IP54

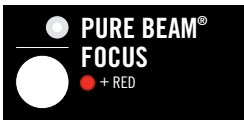

High | Medium | Low
Twist Focus

Weight: 128g | 4.5oz

The FL85 Headlamp is our most powerful front loaded headlamp. The first button on the headlamp gives you the ability to shine an ultra-wide flood beam and then quickly twist the bezel to a long reaching spot beam with transition halo. The second button provides you with a fixed red LED light that helps preserve night vision. Built with an IPX4 weatherproof rating and equipped with a reflective safety strap, this light is ready for any environment.

ANSI FL1 (Aik)	High	Med	Low
Lumens	650	355	100
Beam Distance	192m	145m	77m
Runtime	2h 20min	4h 30min	15h 45min



FEATURES:



TWIST FOCUS



HINGED BEAM



DUAL-COLOR WHITE & RED BEAM



HINGED BEAM



WATER RESISTANCE



HARDHAT COMPATIBLE



REFLECTIVE STRAP



DUAL POWER

ALKALINE-DUAL POWER

3 × AAA battery

ALSO COMPATIBLE WITH:

1 × COAST ZX350 ZITHION-X™ Rechargeable battery (not included)

COAFL75 (805099) 500 Lumens | 150m Beam | IP54



High | Medium | Low
Twist Focus

Weight: 104g | 3.7oz

The FL75 Headlamp combines many modern Coast beam features into one front-loaded headlamp. The first button on the headlamp gives you the ability to shine an ultra-wide flood beam and then quickly twist the bezel to a long reaching spot beam with transition halo. The second button on the headlamp enables the user to switch rapidly to a fixed red LED light to preserve night vision. Built with an IPX4 weatherproof rating and equipped with a reflective safety strap, this light is ready for any environment.

ANSI FL1 (Aik)	High	Med	Low
Lumens	435	255	66
Beam Distance	143m	108m	56m
Runtime	2h 30min	3h	17h



FEATURES:



TWIST FOCUS



HINGED BEAM



DUAL-COLOR WHITE & RED BEAM



HINGED BEAM



WATER RESISTANCE



HARDHAT COMPATIBLE



REFLECTIVE STRAP



DUAL POWER

ALKALINE-DUAL POWER

3 × AAA battery

ALSO COMPATIBLE WITH:

1 × COAST ZX350 ZITHION-X™ Rechargeable battery (not included)

QUALITY SINCE 1919

COAST

COAHL7 (805080)

305 Lumens | 127m Beam | IPX4



Variable Light Tech (VLT)
Twist Focus

Weight: 125g | 4.4oz

The HL7 Headlamp gives you the ability to shine an ultra-wide flood beam and then quickly twist the bezel to a long reaching spot beam with transition halo so that you can be ready for anything. With our Variable Light Control Technology on board you can adjust the light output with the control lever to any point between low and high so you can have highly personalized output and run times.

ANSI FL1 (Aik)	High	Low
Lumens	305	5
Beam Distance	127m	16m
Runtime	2h 15min	85h



LIGHT CONTROL
Control Lever

FEATURES:



ALKALINE-POWER
3 x AAA Alkaline batteries

COAHL5 (805079)

175 Lumens | 56m Beam | IPX4

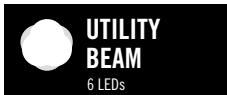

Single Mode

Weight: 125g | 4.4oz

Whether you want to put it on your hardhat or directly on your head, the HL5 Headlamp is a great all-around headlamp for day to day use. Using our Utility Beam Optics, this headlamp produces a diffused beam best suited for up close work.

ANSI FL1 (Aik)	High
Lumens	175
Beam Distance	56m
Runtime	3h 15min



FEATURES:



ALKALINE POWER
3 x AAA Alkaline batteries

PORTABLE WORK LIGHTS



NEW!  **COAPM650R (809488)**

700 Lumens | 200m Beam | IPX4



High | Medium | Low
Twist Focus

Length: 8.4cm | 3.3"
Weight: 340g | 12.0oz

This compact work light is designed to put high quality, bright light anywhere you need it through COAST's patented Pure Beam optic system. The PM650R is compact, rugged, and allows you to work hands-free with a magnetic base that can attach to any metal surface and it provides you 180-degrees of light positioning. The PM650R is one of COAST's embedded rechargeable products that provide the user the convenience and cost savings of a rechargeable power source. The PM650R also includes COAST's patented Pure Beam optic system which allows the user either a wide, consistent flood beam or a far-reaching powerful spot beam with a simple twist of the bezel. The PM650R is dust proof and weather-proof to work in the toughest conditions.



ANSI FL1 (AC/DC) High	
Lumens	300
Beam Distance	150m











ANSI FL1 (Rec)	High	Medium	Low
Lumens	700	375	80
Beam Distance	200m	140m	65m
Runtime	4h	9h	19h



CONTINUOUS RUN OPTION

 Magnetic Base & Hanging Loop

FEATURES:

- 
HIGH MEDIUM LOW
- 
TWIST FOCUS
- 
CONTINUOUS AC/DC POWER
- 
DUAL POWER (LI-ION/CONTINUOUS)
- 
180-DEGREE ROTATION (AREA LIGHT)
- 
BASE HANGING LOOP
- 
MAGNETIC BASE
- 
DUST RESISTANT
- 
WEATHER PROOF
- 
WATER RESISTANCE

DUAL POWER
1 x built-in COAST ZITHION™ Rechargeable battery
USB charging cable

NEW!  **COAWLR1 (809486)** 1150 Lumens | 77m Beam | IP54

FOCUSING FLOOD BEAM
FLOOD & SPOT

High | Medium | Low
Twist Focus

Length: 17.0cm | 6.7"
Weight: 822g | 29oz



Continuous Run Option

Work anywhere, always in the light - using the WLR1 rechargeable portable work light featuring a folding stand, twist-focusing optic, and three output modes for lighting versatility. Held in the hand or set-up on virtually any surface, this dynamic light is equipped with a USB-out port to double as an on-the-go power band for personal devices at the worksite. The WLR1 includes multiple output settings and a focusing optic that can vary the size of the beam. It's compact, rugged, and designed with an adjustable carry-handle stand and includes USB-out function. The powerful, compact floodlight packs a punch at 1150 lumens and the beam can rotate 180-degrees. The work light has an IP54 rating making the light weatherproof and dust proof.

FIVE YEAR WARRANTY

ANSI FL1 (Rec)	High	Medium	Low
Lumens	1150	600	125
Beam Distance	77m	55m	25m
Runtime	3h 15min	6h 45min	13h

FEATURES:



TWIST FOCUS



HIGH MEDIUM LOW



BATTERY LIFE INDICATOR



DUAL POWER (LI-ION/CONTINUOUS)



CONTINUOUS AC/DC POWER



EXTERNAL DEVICE CHARGING



180-DEGREE HANDLE ROTATION



DUST RESISTANT



WATER RESISTANCE



Weatherproof

DUAL POWER

1 × built-in COAST ZITHION™ Rechargeable battery
USB charging cable
USB Power Out

STORM PROOF EMERGENCY AREA LIGHTS (EAL)



EAL TECHNOLOGY — MODES & DURABILITY

LIGHT MODES

HIGH
The brightest light across the broadest area.

MEDIUM
A balance of light intensity and battery life.

ENERGY SAVING
Longest battery life.

SOLID RED
For preserving night vision and reducing glare.

FLASHING RED
A signal light or emergency beacon.

COAST's EAL multi-mode technology allows the user to quickly adjust from energy conserving low light output to area-illuminating high output to anywhere in between. For emergency or night vision purposes switch to solid red mode or flashing red.

SMART SWITCH
Cycle through to optimal light mode.
5-MODE

DURABLE CONSTRUCTION
Water resistant polycarbonate body

STORM PROOF
High-quality materials and durable construction give COAST lanterns excellent weather resistance, making them great for use in emergency situations where there is inclement weather: rain, snow or wind.

STORM PROOF

NEW! COAEAL22 (809485) 1250 Lumens | IP54

SMART SWITCH

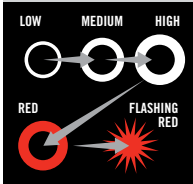

Height: 23.2cm | 9.1"
Weight: 1150g | 40.5oz

Run-time up to 225 hours

The EAL22 is COAST's new emergency area light with features made for any situation where portable lighting is needed. The EAL22 is rated IP54 storm-proof with a sturdy, drop-proof nylon body, polycarbonate dome, and globe construction. Users can also remove the globe to allow for higher lumen output, and with carabiners on the top and bottom, the lantern can be hung to provide overhead lighting with ease.

FIVE YEAR WARRANTY

Globe (Alk)	Low	Medium	High
Lumens	77	675	1250
Beam Distance	5m	16m	20m
Runtime	225h	15h 45mins	7h 30min

Diffuser (Alk)	Low	Medium	High
Lumens	55	465	800
Beam Distance	5m	15m	21m
Runtime	225h	15h 45mins	7h 30min

Globe (Rec)	Low	Medium	High
Lumens	95	875	1575
Beam Distance	5m	17m	24m
Runtime	49h	4h 50mins	2h 15min

Diffuser (Rec)	Low	Medium	High
Lumens	62	590	975
Beam Distance	5m	17m	24m
Runtime	49h	4h 50mins	2h 15min



Removable Diffuser



Hang it



FEATURES:

- DUAL-COLOR WHITE & RED BEAM**
- EMERGENCY**
- ENERGY SAVING**
- HIGH MEDIUM LOW**
- STORM PROOF**
- WATER RESISTANCE**
- BASE HANGING LOOP**

ALKALINE-DUAL POWER
3 x D batteries (not included)

ALSO COMPATIBLE WITH:
1 x COAST ZX1010 ZITHION™ Rechargeable battery (not included)

COA30076 EAL22 ZITHION-X™ ZX1010 RECHARGEABLE BATTERY



STORM PROOF

NEW! **COAEAL13 (809484)** 330 Lumens | IPX4

SMART SWITCH

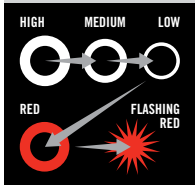

Height: 15.8cm | 6.2"
Weight: 273g | 8.35oz

Run-time up to 120 hours

The EAL13 is the compact, feature-rich portable light that is made for emergency situations both at home or on the go. The EAL13 is rated IPX4 storm proof and built for any situation, with a tough, drop-proof nylon body and polycarbonate dome and globe construction. Users can remove the globe to allow for higher lumen output – and with carabiners on the top and bottom, the lantern can be hung to provide overhead lighting. The EAL13 also features magnets on the underside of the lantern to affix to metal surfaces, as well.

FIVE YEAR WARRANTY

Globe (Alk)	High	Medium	Low
Lumens	330	180	20
Beam Distance	11m	8m	3m
Runtime	4h 45mins	13h	120h

Diffuser (Alk)	High	Medium	Low
Lumens	180	100	10
Beam Distance	10m	7m	2m



Removable Diffuser



Magnetic base



Hang it



Magnetic Base & Hanging Loop

FEATURES:



DUAL-COLOR WHITE & RED BEAM



EMERGENCY



ENERGY SAVING



HIGH MEDIUM LOW



STORM PROOF



WATER RESISTANCE



BASE HANGING LOOP



MAGNETIC BASE

ALKALINE-POWER

3 × AA Alkaline batteries (not included)

MULTI-TOOLS



MULTI-TOOL TECH

FUNCTION FEATURES

SPRING-LOADED PLIERS



Spring-loaded pliers for easy one-handed operation.

EASY-ACCESS TOOLS

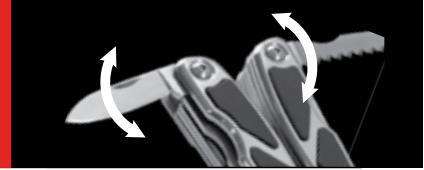

All tools are easily accessible, jaw does not need to be opened.

LIGHT WHERE YOU NEED IT

COAST multi-tools are packed with practicality and built-in LED lights to illuminate work surfaces. The spring-loaded pliers head and lights make them a great choice for working on the car, under the sink, or other tight spaces.



COALED150 (805061)

Pro Pocket Pliers | Spring-loaded pliers | 3Cr13 Stainless steel

- 13 TOOLS**
- 2 LED LIGHTS**

Length: 10.2cm | 4.0" (closed)
Blade: 7.6cm | 3.0"
Weight: 278g | 9.8oz

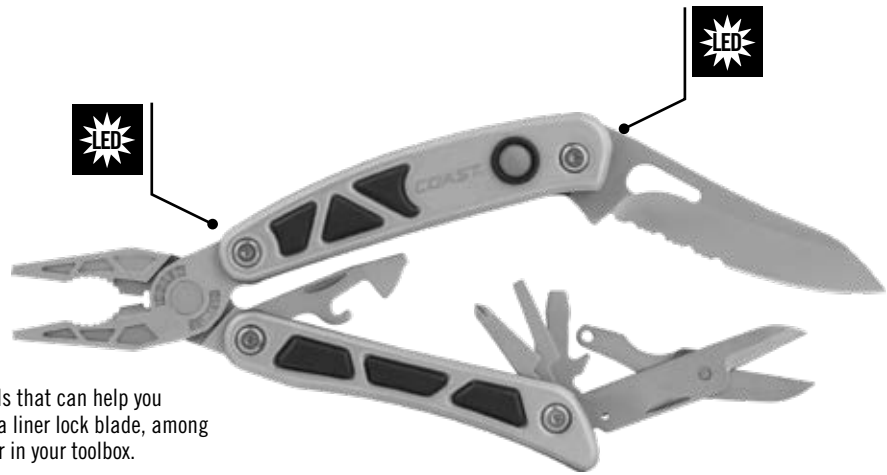

The LED150 Multi-Tool comes packed with 13 tools that can help you master any task or job. Featuring multiple LEDs, a liner lock blade, among many other tools, it is a must-have on your belt or in your toolbox.

Tools Included:

Spring-loaded pliers with wire cutter, 3.0 in. Blade, two built-in LEDs, Phillips (1) and flathead (3) screwdriver tips, bottle opener, wire stripper, can opener.

LITHIUM BATTERY
2 x CR1616 batteries

COALED130 (805060)

Micro Pliers | Spring-loaded pliers | 3Cr13 Stainless steel

- 14 TOOLS**
- 1 LED LIGHT**

Length: 7.6cm | 3.0" (closed)
Blade: 5.1cm | 2.0"
Weight: 122g | 4.3oz



The LED130 Micro Plier comes in a compact size but is still able to squeeze in a total of 14 tools making it a great addition to anyone's keychain or pocket.

Tools Included:

Spring-loaded pliers with wire cutter, 2.0 in. Blade, a built-in LED, saw blade, lanyard hole, Phillips (1) and flathead (3) screwdriver tips, bottle opener, wire stripper, awl, file with nail pick, can opener.

LITHIUM BATTERY
2 x CR927 batteries

COLED155 (809496)

Pro Pocket Pliers | Spring-loaded pliers | 3Cr13 Stainless steel

Coming soon 2021. Check with your stockist

14	TOOLS
	LED LIGHTS

Length: 10.2cm | 4.0" (closed)
Blade: 7.6cm | 3.0"
Weight: 258g | 9.1oz



The LED155 Multi-Tool comes packed with 14 tools that can help you master any task or job. Featuring multiple LEDs, a liner lock blade, among many other tools, it is a must-have on your belt or in your toolbox.

Tools included:

Spring-loaded pliers with wire cutter, 3.0 in. Blade, two built-in LEDs, Phillips (1) and flathead (3) screwdriver tips, bottle opener, wire stripper, can opener.

LITHIUM BATTERY
2 x CR1616 batteries

COLED145 (809497)

Pocket Pliers | Spring-loaded pliers | 3Cr13 Stainless steel

Coming soon 2021. Check with your stockist

13	TOOLS
	LED LIGHT

Length: 9.9cm | 3.9" (closed)
Blade: 6.6cm | 2.6"
Weight: 244g | 8.6oz



With 15 tools, the LED145 Multi-Tool will make you prepared to tackle just about any challenge that arises. Perfect to carry on your belt with a sheath, in your bag or your toolbox.

Tools Included:

Spring-loaded pliers with wire cutter, 2.6in Blade, a built-in LED, saw blade, Phillips (1) and flathead (3) screwdriver tips, bottle opener, awl, file blade with wire stripper, can opener.

LITHIUM BATTERY
2 x CR1220 batteries

COLED135 (809498)

Micro Pliers | Spring-loaded pliers | 3Cr13 Stainless steel

Coming soon 2021. Check with your stockist

14	TOOLS
	LED LIGHT

Length: 7.6cm | 3.0" (closed)
Blade: 5.1cm | 2.0"
Weight: 122g | 4.3oz



The LED135 Micro Plier comes in a compact size but is still able to squeeze in a total of 14 tools making it a great addition to anyone's key chain or pocket.

Tools Included:

Spring-loaded pliers with wire cutter, 2.0 in. Blade, a built-in LED, saw blade, lanyard hole, Phillips (1) and flathead (3) screwdriver tips, bottle opener, wire stripper, awl, file with nail pick, can opener.

LITHIUM BATTERY
2 x CR927 batteries

BATTERY PACKS & ACCESSORIES

COA30447 ZITHION-X™ ZX110 RECHARGEABLE BATTERY

Special order only



COA30446 ZITHION-X™ ZX210 RECHARGEABLE BATTERY

Special order only



COA30317 (809766) ZITHION-X™ ZX310 RECHARGEABLE BATTERY



COA30318 (809767) ZITHION-X™ ZX850 RECHARGEABLE BATTERY



COA30368 (809768) ZITHION-X™ ZX955 RECHARGEABLE BATTERY



COA30316 (809765) ZITHION-X™ ZX1000 RECHARGEABLE BATTERY



COA30445 (809769) ZITHION-X™ ZX960 RECHARGEABLE BATTERY



COA30101 (809764) ZITHION-X™ ZX650 RECHARGEABLE BATTERY



COA21532 (805304) ZITHION-X™ ZX350 RECHARGEABLE BATTERY



COA20838 (805310) ZITHION™ Z500 RECHARGEABLE BATTERY



COA19698 (805343) ZITHION-X™ Z250 A9R BATTERY



COA20661 ZITHION™ Z100 RECHARGEABLE BATTERY

Special order only



COA19702 (805311) MICRO USB CHARGING CABLE



COA30357 USB-C Y SPLIT CHARGING CABLE

Special order only



COA19700 (805305) DC POWER ADAPTER



COA19701 (805312) A9R, A8R PRO-FLEX CABLE



1 COA20040 (805107) AUSTRALIAN POWER PLUG

2 COA20041 (805106) AC POWER ADAPTER

COALF100 (805301) LENS FILTER KIT

4 colors + clear. Fits: HP7R and other lights with similar bezel diameters.



COA20717 HELMET MOUNT KIT

3 mounting options:

- Adhesive mount
- Rubber strap
- Hardhat clips



Special order only

Helmet and headlamp not included

PRODUCT INDEX



	COAXP18R (809489)	COAXP11R (809490)	COAXP9R (809491)	COAXP6R (809492)	COAHP3R (805054)	COAA9R (805341)
BATTERY TYPES	1 × COAST ZITHION-X™ Rechargeable / 6 × AA	1 × COAST ZITHION-X™ Rechargeable / 3 × AAA	1 × COAST ZITHION-X™ Rechargeable / 2 × CR123	1 × COAST ZITHION-X™ Rechargeable / 1 × CR123	1 × COAST ZITHION™ Rechargeable / 2 × AAA	1 × COAST ZITHION™ Rechargeable
LUMENS	Med / High / Low / Turbo 420 / 1460 / 65 / 3650	Med / High / Low / Turbo 330 / 1000 / 75 / 2100	Med / High / Low 350 / 1000 / 67	Med / High / Low 150 / 400 / 35	High / Low 245 / 26	Low 20
RUN TIME	Med / High / Low / Turbo 9h 30min / 6h 30min / 58h 30min	Med / High / Low / Turbo 7h 15min / 5h / 37h	Med / High / Low 8h / 3h 10min / 25h	Med / High / Low 5h / 1h 55min / 10h	High / Low 1h 30min / 6h	Low 3h
BEAM DISTANCE	Med / High / Low / Turbo 110m / 206m / 44m / 330m	Med / High / Low / Turbo 88m / 155m / 42m / 220	Med / High / Low 125m / 225m / 55m	Med / High / Low 110m / 180m / 53	High / Low 93m / 31m	Low 20m
PAGE #	12	13	14	14	16	16



	COAPS700R (809480)	COAPS600 (805062)	COAPS400S (809481)	COAPS200 (805082)	COAPS100 (809482)
BATTERY TYPES	ZITHION-X™ Rechargeable 4 × AA / 1 × COAST	4 × AA	4 × AAA	3 × AAA	2 × AAA
LUMENS	Med / High / Low 380 / 800 / 105	High / Med / Low 710 / 245 / 73	High / Med / Low 440 / 200 / 60	High / Med / Low 320 / 125 / 40	High / Low 110 / 48
RUN TIME	Med / High / Low 11h / 3h 30min / 40h	High / Med / Low 2h 14min / 5h 15min / 30h	High / Med / Low 4h / 10h / 27h	High / Med / Low 4h 30min / 12h / 38h	High / Low 4h 15min / 14h 30min
BEAM DISTANCE	Med / High / Low 175 m / 260 m / 90 m	High / Med / Low 240m / 142m / 78m	High / Med / Low 210m / 140m / 75m	High / Med / Low 120m / 80m / 43m	High / Low 42m / 28m
PAGE #	19	19	20	21	21



	COAHP7 (805057)	COAHX5 (805094)	COAHP3 (805052)	COAG20 (805076)
BATTERY TYPES	4 × AAA	1 × AA / 1 × NiMH / 1 × COAST ZITHION-X™ Rechargeable	2 × AAA	2 × AAA / 1 × COAST ZITHION-X™ Rechargeable
LUMENS	High / Med / Low 650 / 330 / 90	168 (Alkaline) 125 (NiMH) 360 (Li Ion)	High / Low 105 / 5	-
RUN TIME	High / Med / Low 3h / 3h 15min / 6h 30min	3h 15min (Alkaline) 1h 15min (NiMH) 1h 10 min (Li Ion)	High / Low 2h 15min / 3h 30min	High 11h
BEAM DISTANCE	High / Med / Low 200m / 135m / 75m	88m (Alkaline) 77m (NiMH) 130m (Li Ion)	High / Low 62m / 13m	High 21m
PAGE #	23	23	24	24



	COAG15 (805075)	COAHX4 (805673)	COAHX3 (805674)
BATTERY TYPES	1 × AAA	2 × AAA	2 × AAA
LUMENS	-	High 80	High 80
RUN TIME	High 2h 30min	High 3h 45min	High 3h 45min
BEAM DISTANCE	High 20m	High 13m	High 13m
PAGE #	24	25	25



	COAXPH34R (809493)	COAXPH30R (809494)	COAXPH25R (809495)
BATTERY TYPES	1 × COAST ZITHION-X™ Rechargeable / 3 × AAA	1 × COAST ZITHION-X™ Rechargeable / 2 × CR123	1 × COAST ZITHION-X™ Rechargeable / 1 × CR123
LUMENS	Med / High / Low / Turbo 330 / 1025 / 73 / 2075	Med / High / Low / Turbo 150 / 490 / 40 / 1000	Med / High / Low 155 / 410 / 42
RUN TIME	Med / High / Low / Turbo 11h 15min / 6h 15min / 36h	Med / High / Low / Turbo 10h / 7h 45min / 41h	Med / High / Low 4h 15min / 1h 45min / 9h 15min
BEAM DISTANCE	Med / High / Low / Turbo 78m / 136m / 36m / 195m	Med / High / Low / Turbo 63m / 112m / 31m / 165m	Med / High / Low 75m / 120m / 38m
PAGE #	27	28	28



	COAHL7R (805081)	COAFL85 (805100)	COAFL75 (805099)	COAHL7 (805080)	COAHL5 (805079)
BATTERY TYPES	3 × COAST ZITHION™ Rechargeable / 3 × AAA	3 × AAA / 1 × COAST ZITHION-X™ Rechargeable	3 × AAA / 1 × COAST ZITHION-X™ Rechargeable	3 × AAA	3 × AAA
LUMENS (Rec)	High / Low 240 / 4				
LUMENS (Aik)	-	High / Med / Low 650 / 355 / 100	High / Med / Low 435 / 255 / 66	High / Low 305 / 5	High 175
RUN TIME (Rec)	High / Low 1h 30min / 40h	-			
RUN TIME (Aik)	-	High / Med / Low 2h 20min / 4h 30min / 15h 45min	High / Med / Low 2h 30min / 3h / 17h	High / Low 2h 15min / 85h	High 3h 15min
BEAM DISTANCE (Rec)	High / Low 104 m / 13 m	-			
BEAM DISTANCE (Aik)	-	High / Med / Low 192m / 145m / 77m	High / Med / Low 143m / 108m / 56m	High / Low 127m / 16m	High 56m
PAGE #	31	32	32	33	33



	COAPM650R (809488)	COAWLR1 (809486)	COAEAL22 (809485)	COAEAL13 (809484)
BATTERY TYPES	1 x built-in COAST ZITHION™ Rechargeable/ AC DC	1 x built-in COAST ZITHION™ Rechargeable /AC	1 x COAST ZITHION-X™ Rechargeable battery / 3 x D	3 x AA
LUMENS (Rec)	High / Med / Low 700 / 375 / 80 AC DC: 300	High / Med / Low 1150 / 600 / 125		-
LUMENS (Aik) GLOBE	-	-	Low / Med / High (Globe) 77 / 675 / 1250	High / Med / Low(Globe) 330 / 180 / 20
LUMENS (Aik) DIFFUSER	-	-	Low / Med / High (Diffuser) 55 / 465 / 800	High / Med / Low(Diffuser) 180 / 100 / 10
RUN TIME (Rec)	High / Med / Low 4h / 9h / 19h	High / Med / Low 3h 15min / 6h 45min / 13h		
RUN TIME (Aik)	-	-	Low / Med / High 225h / 15h 45min / 7h 30min	High / Med / Low 4h 45min / 13h / 120h
BEAM DISTANCE (Rec)	High / Med / Low 200m / 140m / 65m AC DC: 150m	High / Med / Low 77m / 55m / 25m		-
BEAM DISTANCE (Aik) GLOBE	-	-	Low / Med / High (Globe) 5m / 16m / 24m	High / Med / Low (Globe) 11m / 8m / 3m
BEAM DISTANCE (Aik) DIFFUSER	-	-	Low / Med / High (Diffuser) 5m / 15m / 21m	High / Med / Low (Diffuser) 10m / 7m / 2m
PAGE #	35	36	39	40



	COALD155 (809496)	COALD150 (805061)	COALD145 (809497)	COALD135 (809498)	COALD130 (805060)
BATTERY TYPES	2 x CR1616	2 x CR1616	2 x CR1220	2 x CR927	2 x CR927
BLADE LENGTH	7.6cm / 3.0in	7.6cm / 3.0in	6.6cm / 2.6in	5.1cm / 2.0in	5.1cm / 2.0in
OVERALL LENGTH	10.2cm / 4.0in (closed)	10.2cm / 4.0in (closed)	9.9cm / 3.9in (closed)	7.6 cm / 3.0in (closed)	7.6cm / 3.0in (closed)
NUMBER OF TOOLS	14	13	13	14	13
NUMBER OF LEDS	2	2	1	1	1
HANDLE MATERIAL	Stainless Steel	Stainless Steel	Stainless Steel	Stainless Steel	Stainless Steel
PAGE #	44	43	44	44	43

Available from your local Coast distributor

P_AUS_T_COAST_BR_2021

WHITE INTERNATIONAL PTY LTD

60 Ashford Ave Milperra NSW 2214
PO Box 304 Milperra NSW 2214
Phone 02 9783 6000 Fax 02 9783 6001
Customer Service 1300 780 876
Email Sales: sales@whiteint.com.au
www.whiteint.com.au

**Please always refer to our website for further
technical information & new product innovations**

Disclaimer: Every effort has been made to publish the correct details in this brochure.
No responsibility will be taken for errors, omissions or changes in product specifications.
Product images are representations only.



Scan QR Code on your
smart phone or iPad to
save a digital version.

